

FF 120T FF 220T

EXTRON PATENTED FLAT FIELD® SPEAKER WITH TRANSFORMER



FF 120T



FF 220T

The Extron FF 120T and FF 220T are full-range ceiling tile speakers for 70/100 volt systems. Their UL 2043 plenum rated, low profile enclosures fit easily into suspended ceilings. The full-range driver delivers accurate voice and music reproduction using Extron's patented Flat Field Technology, providing consistent sound levels across the listening area, and reducing the number of speakers required. An exclusive horn-loaded design significantly enhances low frequency response. The FF 120T and FF 220T are ideally suited for rooms with drop-in tile ceilings where sound must be distributed evenly to all listeners.

- ▶ Drop-in ceiling tile speaker for suspended ceilings
- ▶ UL 2043 plenum rated enclosure
- ▶ Extron patented Flat Field Technology
- ▶ Delivers consistent sound levels across the listening area and reduces the number of speakers required
- ▶ Full-range driver with horn-loaded design provides extended low frequency reproduction
- ▶ White perforated grille matches appearance of air conditioning vents
- ▶ 70/100 volt operation
- ▶ 16 watts continuous pink noise, 32 watts continuous program rated
- ▶ Wide 170° dispersion
- ▶ Fast installation reduces labor cost
- ▶ FF 220T versions available for US 2' x 2' or metric 600 mm x 600 mm ceiling grids
- ▶ Low profile enclosure for plenum environments
- ▶ 5 year parts and labor warranty
- ▶ Patented; designed and manufactured by Extron



Extron Electronics
INTERFACING, SWITCHING AND CONTROL

DESCRIPTION

The Extron **FF 120T** and **FF 220T** are full-range ceiling tile speakers for 70/100 volt systems. They feature UL 2043 plenum rated enclosures that drop into suspended ceilings, resting directly on the T-bar support grid and replacing a portion of an existing ceiling tile. Designed with low profile enclosures, these speakers are an excellent choice for ceiling installations with tight above-the-ceiling space issues, such as air handling duct work installed close to the ceiling. The full-range driver features a wide frequency range of 68 Hz to 18 kHz, 16 watts continuous pink noise and 32 watts continuous program capacity. The FF 120T and FF 220T achieve an unusually deep bass response with our exclusive horn-loaded driver.

Patented Flat Field Technology

Extron's patented Flat Field Technology makes this speaker truly unique. Flat Field Technology allows the FF 120T and FF 220T to reduce beaming of mid and high frequencies directly under the speaker, delivering consistent sound levels across the listening area.

Extremely Wide Sound Dispersion

The FF 120T and FF 220T offer an extraordinarily wide dispersion of 170 degrees, which provides a very wide room coverage pattern. This is especially important for rooms with low ceilings.

These speakers are ideal for use in low ceiling installations for maximum room coverage. This coverage optimizes voice intelligibility, which along with low bass response, is the most critical consideration for microphone and program material applications. The FF 120T and FF 220T provide excellent voice clarity without compromising music reproduction.

Two FF 220T versions are available: a 2' x 2' version for US standard ceilings and a 600 mm x 600 mm version for metric ceilings.

For easy installation and theft deterrence, the FF 120T and FF 220T feature a neutral white, perforated steel grille and included T-bar, which matches the appearance of standard air conditioning vents and grid ceilings.

FEATURES

- ▶ Drop-in ceiling tile speaker for suspended ceilings
- ▶ UL 2043 plenum rated enclosure
- ▶ Extron patented Flat Field Technology for consistent sound levels across the listening area, reducing the number of speakers required
- ▶ 3" (7.6 cm) horn-loaded, full-range driver provides extended low frequency reproduction
- ▶ White perforated grille matches appearance of air conditioning vents
- ▶ 8 ohm direct or 70/100 volt operation with 16, 8, 4, 2, and 1 watt selectable power taps accessed via speaker wiring connections inside the rear panel
- ▶ Frequency range: 68 Hz to 18 kHz
- ▶ 16 watts continuous pink noise, 32 watts continuous program rated
- ▶ Wide 170° dispersion
- ▶ FF 220T versions available for US and metric ceilings
- ▶ 3.25" (8.3 cm) deep low profile enclosure for plenum environments
- ▶ 5 year parts and labor warranty
- ▶ Patented; designed and manufactured by Extron

Does Your Ceiling Speaker Really Meet UL Standards?

Not all ceiling speakers on the market are UL listed. Those that are may be listed for commercial and professional use, but do not have the appropriate UL rating for installation and use in a plenum airspace. Because the space above a suspended tile ceiling is often used as a plenum air return for the HVAC system, it is essential that ceiling speakers have been properly tested and rated for minimal smoke and heat release in the event of a fire and to comply with building codes.

UL Listed and Plenum Rated

A UL mark does not guarantee plenum applicability. Extron closed back ceiling speakers, however, are UL listed indicating they conform to specified safety standards. The FF 120T and FF 220T are UL 2043 listed for use in air handling spaces. They are also UL 1480 listed for commercial and professional use. Always check a speaker's certification on UL's Web site, www.ul.com, and use the Online Certifications Directory tool before you specify it for a plenum ceiling application.

SPECIFICATIONS

AUDIO/ACOUSTIC AND ELECTRICAL		
Speaker type	1-way, full-range, in-ceiling speaker	
Frequency range	68 Hz to 18 kHz, -10 dB, half space	
Power capacity	16 W (rms) continuous pink noise 32 W (rms) continuous program	
Nominal sensitivity	86 dB SPL, 1 watt, 1 m, half space	
Nominal coverage angle	170° conical coverage	
Nominal impedance	8 ohms per speaker	
Driver	(1) 3" (76.2 mm) paper cone	
Tap settings		
70 V input	16 W, 8 W, 4 W, 2 W, 1 W, null (bypass 8 ohm direct connection)	
100 V input	Null, 16 W, 8 W, 4 W, 2 W, 1 W (bypass 8 ohm direct connection)	
GENERAL		
Package	2 speakers (1 pair) with 2' (61 cm) cross bars	
US version	Drops into 2' x 2' (61 cm x 61 cm) or 2' x 4' (61 cm x 122 cm) suspended tile ceilings	
Metric version	Drops into 600 mm x 600 mm or 600 mm x 1200 mm suspended tile ceilings	
Enclosure outer dimensions		
FF 120T	3.25" H x 23.75" W x 11.75" D (8.3 cm H x 60.3 cm W x 29.9 cm D)	
FF 220T		
US version (2' x 2')	3.25" H x 23.75" W x 23.75" L (8.3 cm H x 60.3 cm W x 60.3 cm L)	
Metric version (600 mm x 600 mm)	3.25" H x 23.4" W x 23.4" L (8.3 cm H x 59.4 cm W x 59.4 cm L)	
Product weight		
FF 120T	Single: 5.1 lbs (2.3 kg)	
FF 220T	Single: 7.8 lbs (3.5 kg)	
Regulatory compliance		
Safety	CE, NFPA90A, NFPA70; UL Listed for use in plenum airspaces: meets UL 2043 for heat and smoke release, meets UL 1480 for commercial and professional audio systems	
Environmental	Complies with the appropriate requirements of RoHS, WEEE.	
Warranty	5 years parts and labor	
Model	Version Description	Part number
FF 120T	Ceiling - 1x2 Drop-In, Xfmr, Pair	42-120-13
FF 220T	Ceiling - 2x2 Drop-In, Xfmr, Pair	42-141-03
FF 220T	Ceiling - 600x600 Drop-In, Xfmr, Pair	42-141-23

For complete specifications, please go to www.extron.com
Specifications are subject to change without notice.

ADVANTAGES OF FLAT FIELD® TECHNOLOGY

Many traditional ceiling speakers have difficulty providing even sound pressure levels throughout a room with a limited number of speakers. Typical results include gaps in coverage or hot spots. Extron patented Flat Field Technology eliminates these difficulties by redirecting sound waves to better equalize perceived sound pressure levels across the listening plane.

To learn more about Extron Flat Field Technology, see our white paper at www.extron.com/flatfieldpaper.

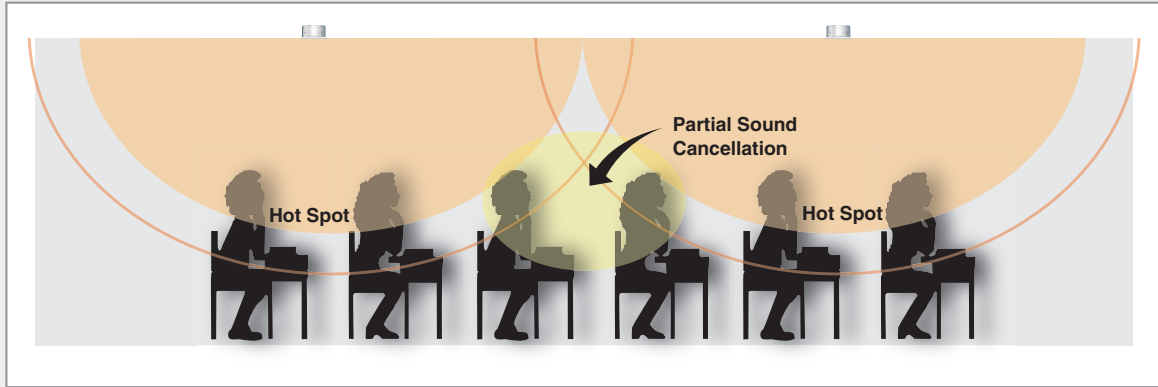

Coverage pattern of a typical ceiling speaker showing hot spots and areas of cancellation.

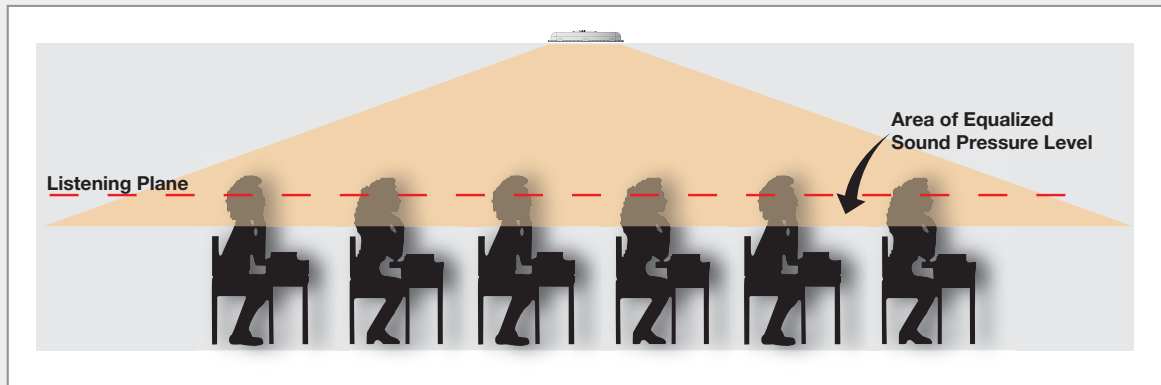

Coverage pattern of Flat Field Technology showing equalized sound pressure levels.

EASY TO INSTALL

The FF 120T and FF 220T are designed for quick and easy installation into standard suspended tile ceilings. All that is necessary is to remove an existing ceiling tile, make the speaker wiring connections, and then place the FF 120T or FF 220T onto the T-bar support grid. Multiple seismic tabs simplify speaker anchoring. The process requires minimal effort and time without any pre-installation procedures necessary for the typical round speaker, such as cutting holes through ceiling tiles and mounting supporting hardware.

If necessary, simply cut the existing ceiling tile to fill out the space adjacent to the speaker and the included T-bar. The end result is a clean and inconspicuous speaker system that requires just minutes to install.



Installation in three easy steps: (1) Remove ceiling tile, (2) Make wiring connections, (3) Place speaker on grid and anchor with seismic tabs. Trim ceiling tile, if necessary, to fit with provided T-bar.

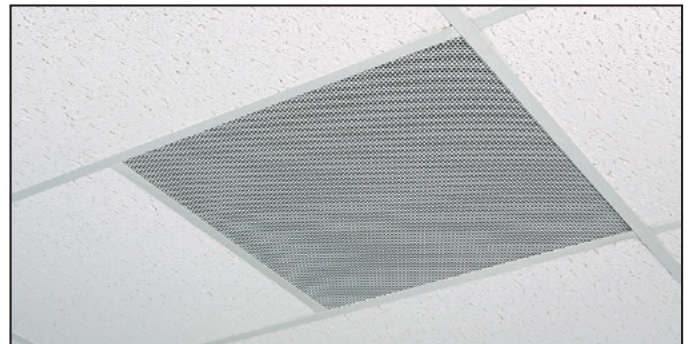

The inconspicuous white grille allows the FF 120T or FF 220T to blend into the ceiling.

POLAR GRAPHS - 1/3 OCTAVE, HORIZONTAL

100.00 Hz 160.00 Hz
125.00 Hz 200.00 Hz

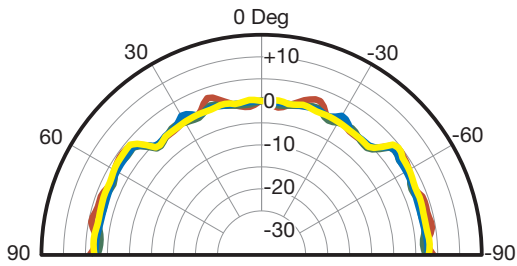

100 Hz - 200 Hz

250.00 Hz 400.00 Hz
315.00 Hz 500.00 Hz

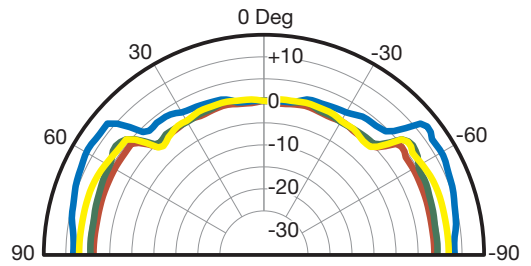

250 Hz - 500 Hz

630.00 Hz 1.00 kHz
800.00 Hz 1.25 kHz

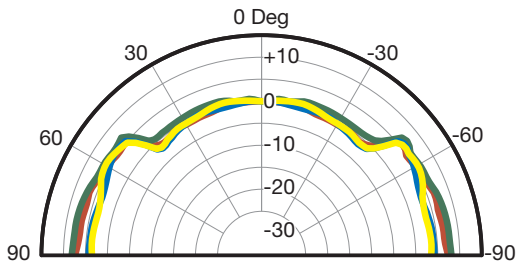

630 Hz - 1.25 kHz

1.60 kHz 2.50 kHz
2.00 kHz 3.15 kHz

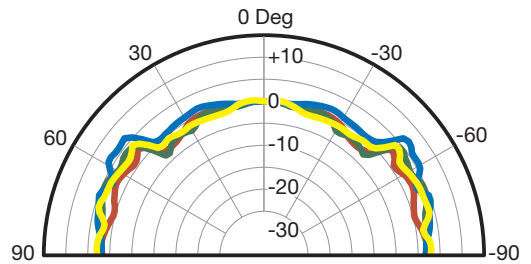

1.6 kHz - 3.15 kHz

4.00 kHz 6.30 kHz
5.00 kHz 8.00 kHz

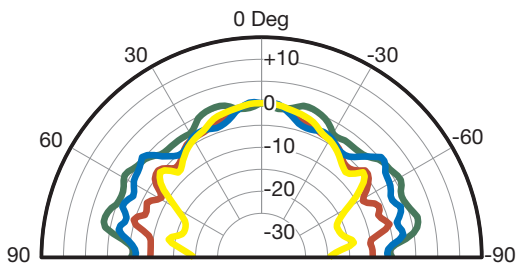

4 kHz - 8 kHz

10.00 kHz 16.00 kHz
12.50 kHz 20.00 kHz

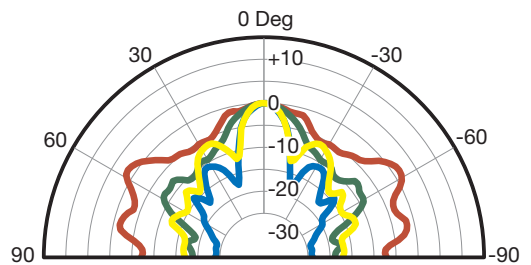

10 kHz - 20 kHz

RESPONSE GRAPHS - FREQUENCY AND IMPEDANCE

SPL VS. FREQUENCY - 1 WATT @ 1 METER RESPONSE, HALF SPACE (2π)

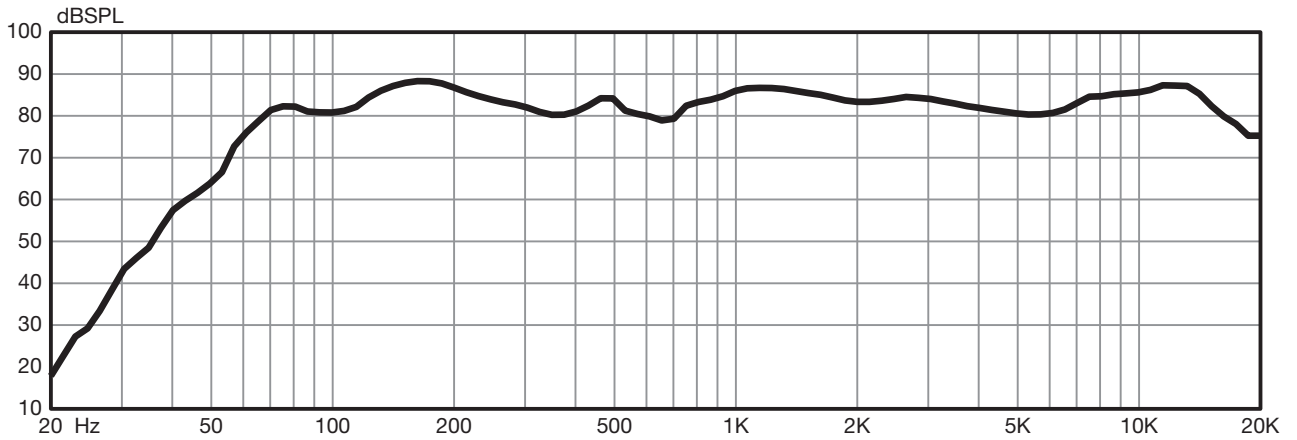

SPL VS. FREQUENCY - HORIZONTAL OFF-AXIS RESPONSE, HALF SPACE (2π)

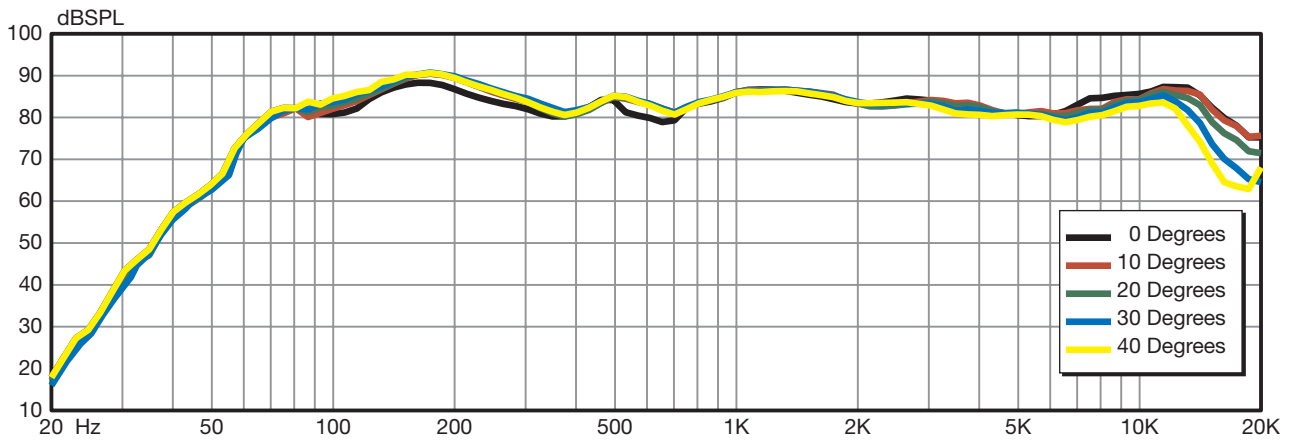

IMPEDANCE VS. FREQUENCY

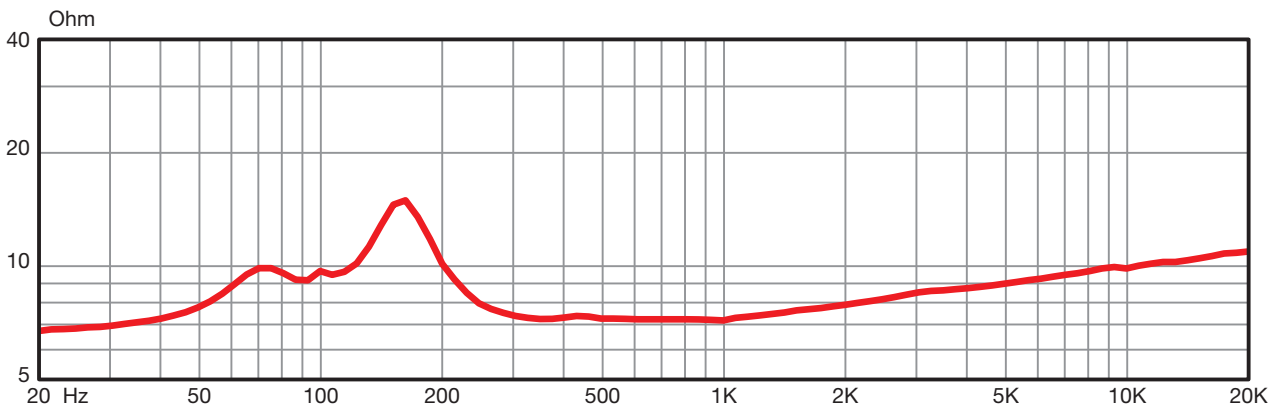

PANEL DRAWINGS

FF 120T

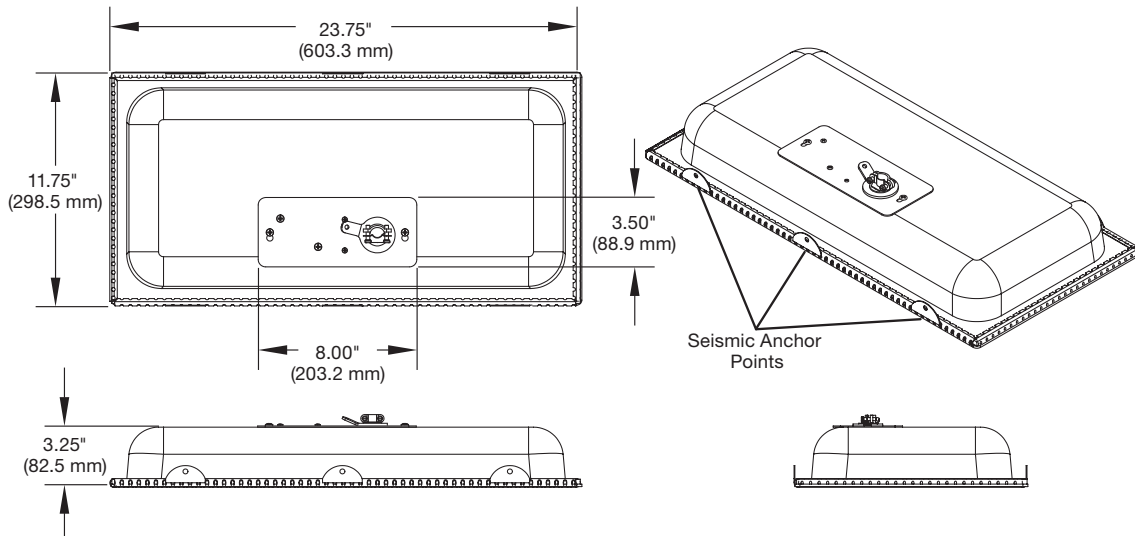

FF 220T

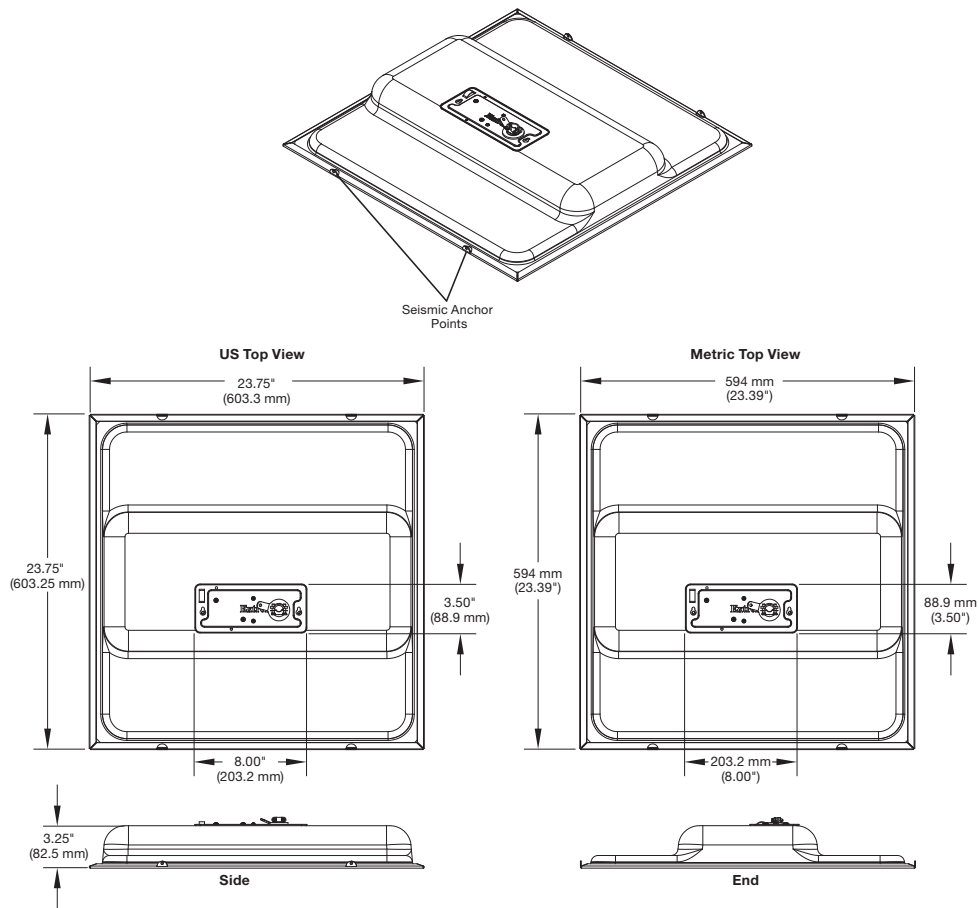

Worldwide Sales Offices

Anaheim • Raleigh • Silicon Valley • Dallas • New York • Washington, DC • Toronto • Mexico City • Paris • London • Frankfurt
Amersfoort • Moscow • Dubai • Johannesburg • New Delhi • Bangalore • Singapore • Seoul • Shanghai • Beijing • Tokyo

UNITED STATES

+800.633.9876
Inside USA/Canada
+1.714.491.1500

EUROPE

+800.3987.6673
Inside Europe
+31.33.453.4040

ASIA

+800.7339.8766
Inside Asia
+65.6383.4400

MIDDLE EAST

+971.4.299.1800